

01 / Set Up Your Camera

STEP 1

DOWNLOAD APP

Get the **Tapo** app from the App Store or Google Play.

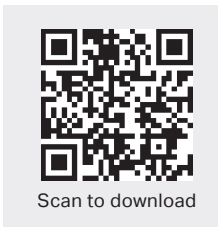

STEP 2

POWER UP

Connect the camera to a power outlet using the provided power adapter. Install the waterproof seal for the power connectors.

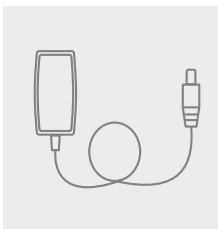

STEP 3

SET UP

Tap the **+** button in the app and select your model. Follow the app instructions to complete setup.



02 / Mount Your Camera



The camera is not waterproof when set on a table or shelf. Mount the camera via Option 1 or 2 when installing outdoors.

Option 1: Wall Mount

1. Affix the Camera and Bracket

Route the camera power cord and Ethernet cable through the opening of the bracket. Use two bracket screws to affix the bracket and the camera.

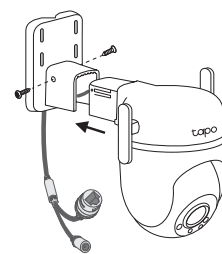

2. Drill Holes

Stick the mounting template to the desired mounting place. Drill four screw holes according to the template.

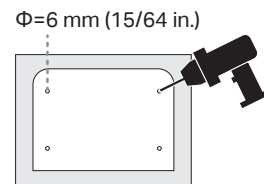

3. Mount the Camera

Insert four mounting anchors into the holes, then use the mounting screws to affix the camera and bracket over the anchors.

Note: Adjust the external antennas to be vertical for the best Wi-Fi signal.

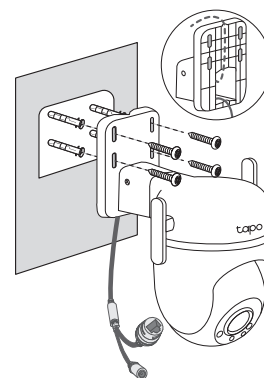

4. Power Up the Camera

Install the waterproof seal and power up the camera.

Option 2: Overhang Mount

1. Affix the Camera and Bracket

Route the camera power cord and Ethernet cable through the opening of the bracket. Use two bracket screws to affix the bracket and the camera.

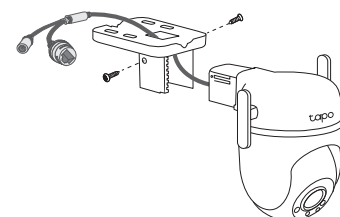

2. Drill Holes

Stick the mounting template to the desired mounting place. Drill four screw holes according to the template.

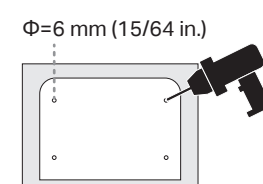

3. Mount the Camera

Insert four mounting anchors into the holes, then use the mounting screws to affix the camera and bracket over the anchors.

Note: Adjust the external antennas to be vertical for the best Wi-Fi signal.

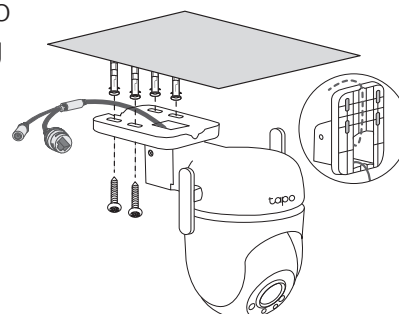

4. Power Up the Camera

Install the waterproof seal and power up the camera.

Option 3: Pole Mount

1. Affix the Camera and Bracket

Route the camera power cord and Ethernet cable through the opening of the bracket. Use two bracket screws to affix the bracket and the camera.

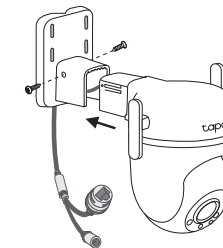

2. Mount the Camera

Mount the camera on the pole using two pole-mounting loops* (loop width ≤ 12mm).

*Pole-mounting loops are not included.

Note: Adjust the external antennas to be vertical for the best Wi-Fi signal.

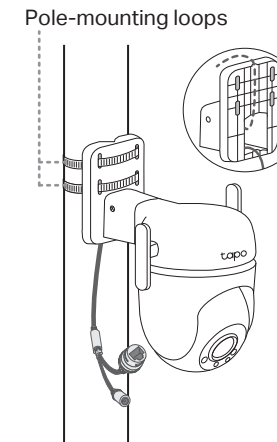

3. Power Up the Camera

Install the waterproof seal and power up the camera.

03 / Install Waterproof Cable Attachments

Install the waterproof cable attachments for the network interface. Make sure each part is securely attached and the waterproof rings are flush to keep out water.

The Ethernet port connects to a network device.

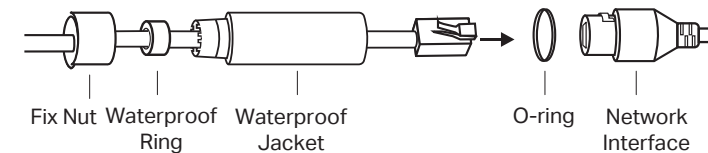

1. Route the network cable through the following components in order: fix nut, waterproof ring, and then the waterproof jacket.
2. Insert the waterproof ring into the waterproof jacket.
3. Fix the O-ring to the network interface of the camera and connect the network cables.
4. Attach the network interface with the waterproof jacket, then twist to lock. Rotate the fix nut to secure it to the waterproof jacket.

The Ethernet port does not connect to a network device.

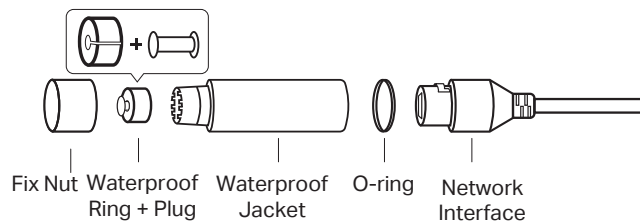

1. Insert the waterproof plug into the waterproof ring, then insert them into the waterproof jacket.
2. Fix the O-ring to the network interface of the camera. Attach the network interface with the waterproof jacket, then twist to lock. Rotate the fix nut to secure it to the waterproof jacket.

Appearance

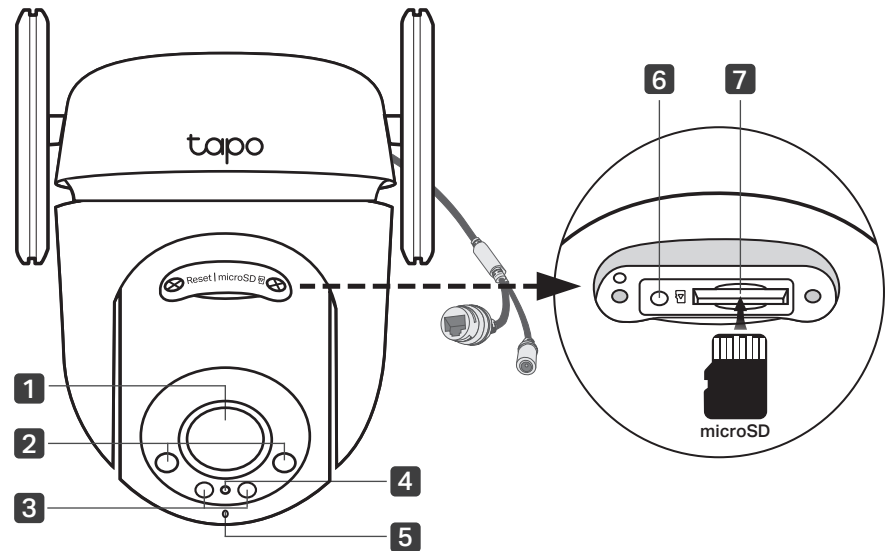

1 Lens

2 White Light LEDs

3 IR LEDs

4 System LED

5 Microphone

6 Reset

Loosen the screws. While the camera is powered on, use a pin to press and hold the Reset button for at least 5 seconds until the System LED blinks red. The camera will reset and reboot.

7 microSD Card Slot

Loosen the screws and insert a microSD card*. Initialize it on the Tapo app for local recording.

*microSD card not included

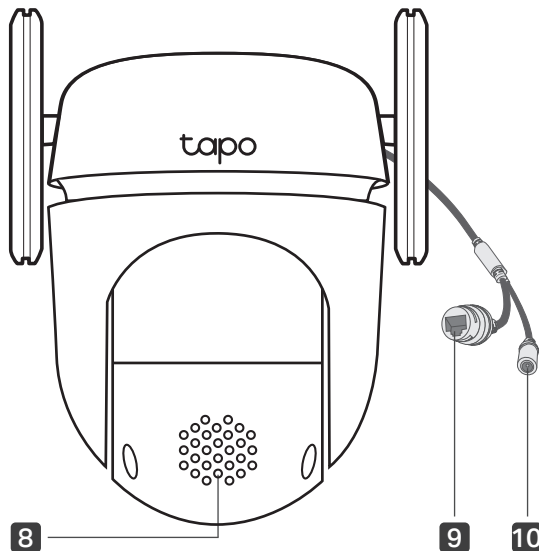

8 Speaker

9 Ethernet Port

Used to connect to a network device

10 DC Power Connector

Used to connect to a 9V DC power adapter

System LED Indication

Solid red	Starting up
Blinking red and green (for Wi-Fi setup)	Ready for setup
Blinking red slowly (for Wi-Fi setup)	Connecting to Wi-Fi
Solid amber	Connected to Wi-Fi or wired network
Solid green	Connected to the cloud
Blinking red quickly	Camera resetting
Blinking green quickly	Camera updating



For technical support, the user guide, and more information, please visit www.tapo.com/support/



Safety Information

- Do not use damaged charger or USB cable to charge the device.
- Do not use any other chargers than those recommended.
- Do not use the device where wireless devices are not allowed.
- Adapter shall be easily accessible.
- Use only power supplies which are provided by manufacturer and in the original packing of this product. If you have any questions, please don't hesitate to contact us.
- Keep the device away from fire or hot environments. DO NOT immerse in water or any other liquid.
- Do not disassemble, repair or modify the product.
- Do not use the product if the casing has been broken. Danger of electric shock.
- Never touch the product with wet hands.
- Do not place near automatically controlled devices such as fire alarms. Radio waves emitted from this product may cause such devices to malfunction resulting in an accident.
- Observe restrictions on using wireless products in fuel depots, chemical plants or when blasting operations are in progress.
- Do not use liquid to clean the product. Only use a dry cloth.
- Never put metal objects inside the product. If a metal object enters the product turn off the circuit breaker and contact an authorised electrician.
- This product is not intended to be used when providing medical care. Consult the manufacturer of any personal medical devices, such as pacemakers or hearing aids to determine if they are adequality shielded from external RF (radio frequency) energy.
- Do not use this product in health care facilities. Hospitals or health care facilities may be using equipment that could be sensitive to external RF energy.
- Do not place heavy objects on top of the product.
- When you leave the product unused for a long time unplug the product from the power outlet.
- This product may interfere with other electronic products such as TV, radios, personal computers, phones or other wireless devices.
- Adapter should be used indoors where the ambient temperature is lower than or equal to 40°C.
- Operating Temperature: -30 °C ~ 60 °C (-22°F ~ 140°F)

Please read and follow the above safety information when operating the device. We cannot guarantee that no accidents or damage will occur due to improper use of the device. Please use this product with care and operate at your own risk.

TP-Link hereby declares that the device is in compliance with the essential requirements and other relevant provisions of directives 2014/53/EU, 2009/125/EC, 2011/65/EU and (EU)2015/863. The original EU declaration of conformity may be found at <https://www.tapo.com/support/ce>

TP-Link hereby declares that the device is in compliance with the essential requirements and other relevant provisions of the Radio Equipment Regulations 2017. The original UK declaration of conformity may be found at <https://www.tapo.com/support/ukca/>



Quick Start Guide

Outdoor Pan/Tilt Security Wi-Fi Camera

©2023 TP-Link 7106510356 REV1.1.0

*Images may differ from your actual product.